

Installation Manual For 260.2400

4-Hole Deck Mount Roman Tub Filler With Hand Shower

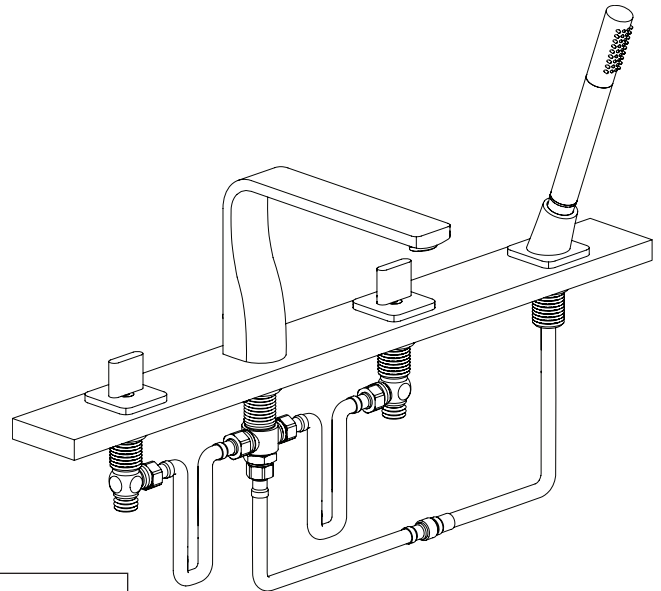

NOTICE TO HOMEOWNER

- We recommend that this product is installed by a qualified professional plumber.
- Please check this product immediately to ensure that it has not been damaged and is complete. Before installation, please make sure this product is the correct model and you have all the parts required for installation and use.
- Please flush the water system to ensure that no metal swarf, solder, and other impurities can enter the product.
- Turn off water supply before commencing work.
- Please read these instructions carefully and retain for future reference.



UNDER DECK ACCESS
PANEL IS REQUIRED FOR
MAINTENANCE AND
REPAIR OF DIVERTER
MECHANISM AND
CARTRIDGES

BEFORE YOU BEGIN

- You must observe all local plumbing laws and codes.
- Do not instal valve if it does not meet local plumbing codes.
- Shut off the main water supply.

Installation Manual For 260.2400

4-Hole Deck Mount Roman Tub Filler With Hand Shower

TABLE OF CONTENTS

OPERATING SPECIFICATIONS	3
INSTALLING THE HOT & COLD HANDLES	4
INSTALLING THE TUB SPOUT	6
INSTALLING THE HAND SHOWER	8
INSTALLING THE HOSES	9
TROUBLESHOOTING THE DIVERTER	10

OPERATING SPECIFICATIONS

WATER TEMPERATURE



This product is to be used with water at a temperature range of 40° - 120° ONLY!

WATER PRESSURE



This product is to be used with a water pressure range of 15 PSI to 80 PSI ONLY

If water pressure is greater than 80 PSI, install a pressure reducer valve (PRV)

This valve meets or exceeds ANSI A112.18.1 and ASSE 1016

INSTALLING THE HOT & COLD HANDLES

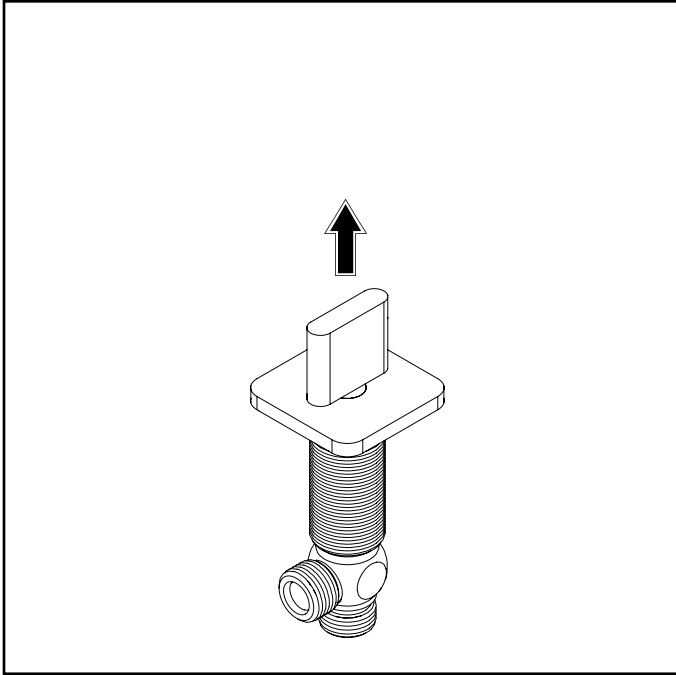

Remove handle from valve

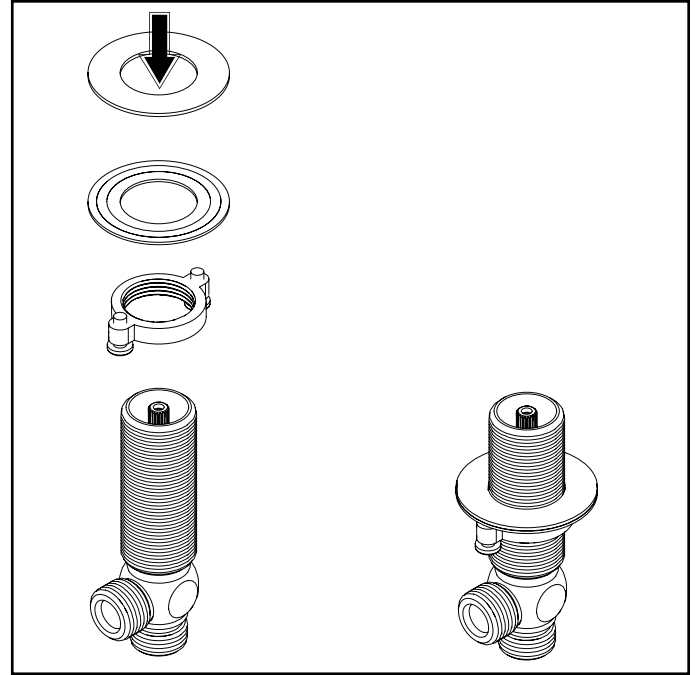

Install nut and washers onto valve

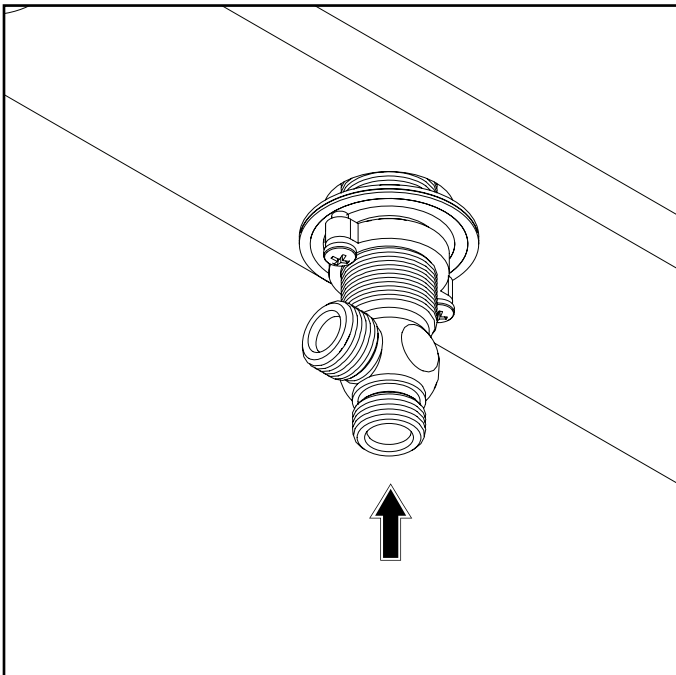

Insert valve into 1-3/8" hole from below the deck

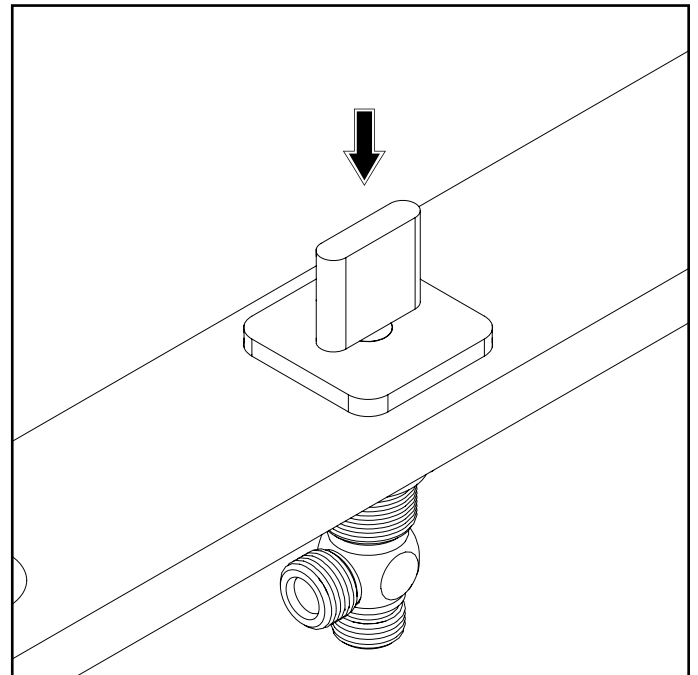

Install body from top of deck and twist to tighten

INSTALLING THE HOT & COLD HANDLES

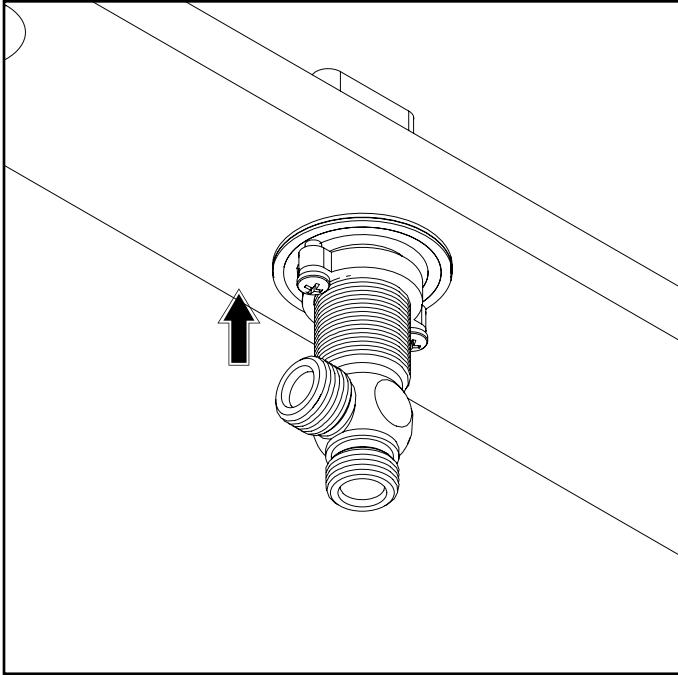

Tighten nut and washers from bottom of deck

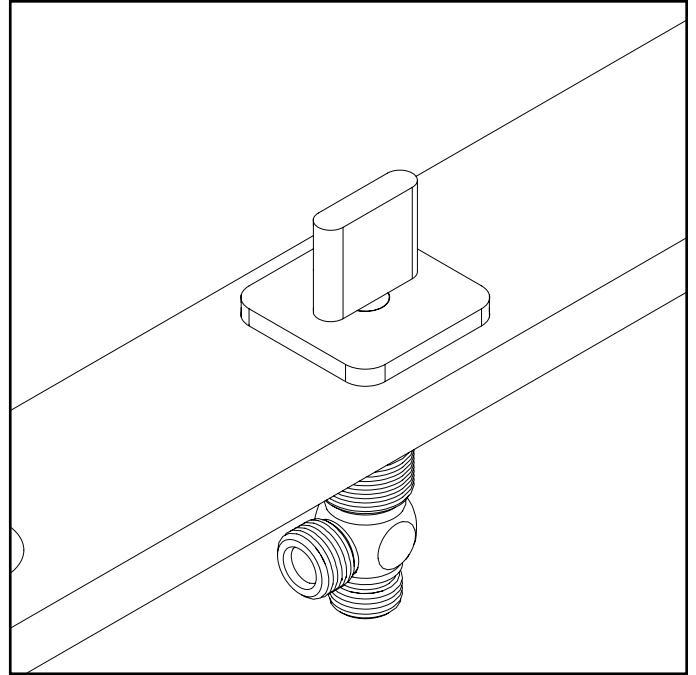

Twist to verify smooth operation

INSTALLING THE TUB SPOUT

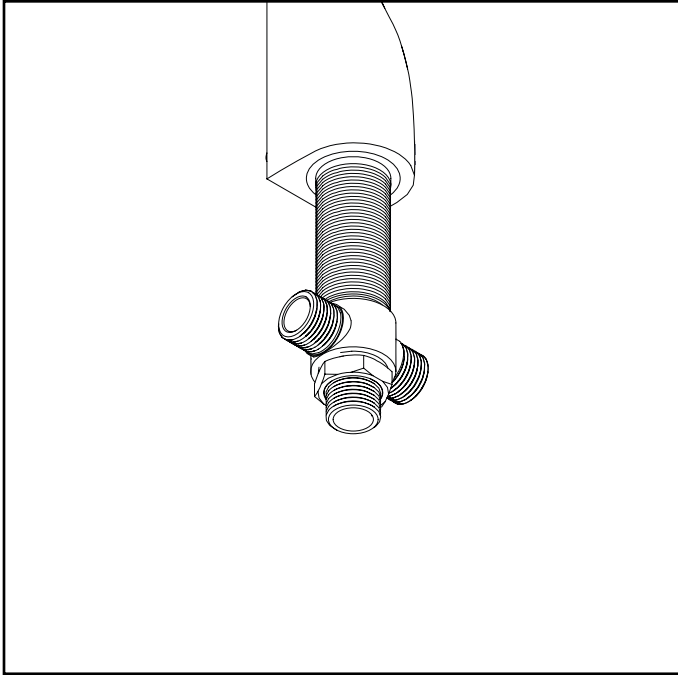

The spout diverter valve is seen above

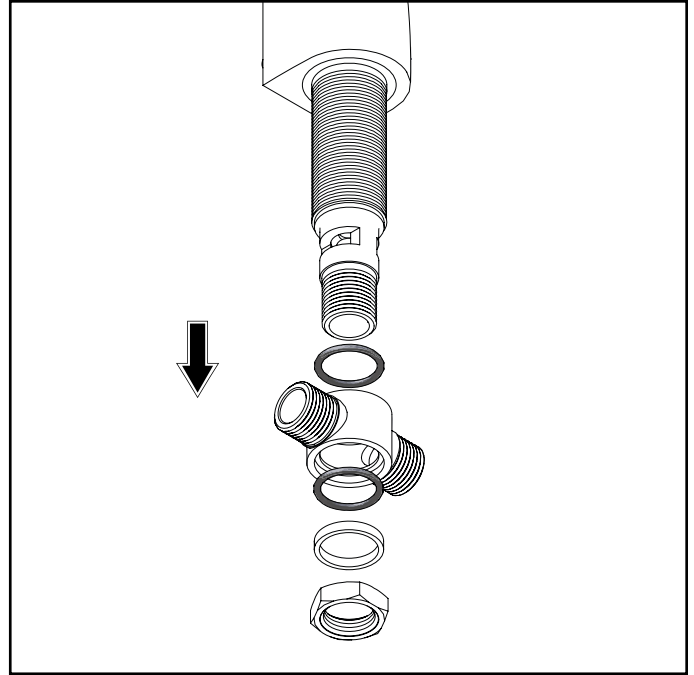

Remove components from diverter valve

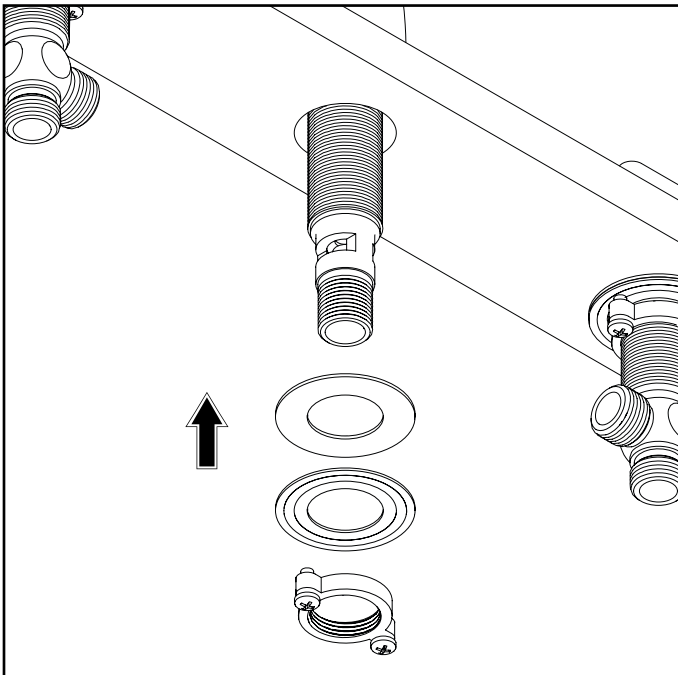

Insert spout into deck hole, then insert washers and tighten retaining nut

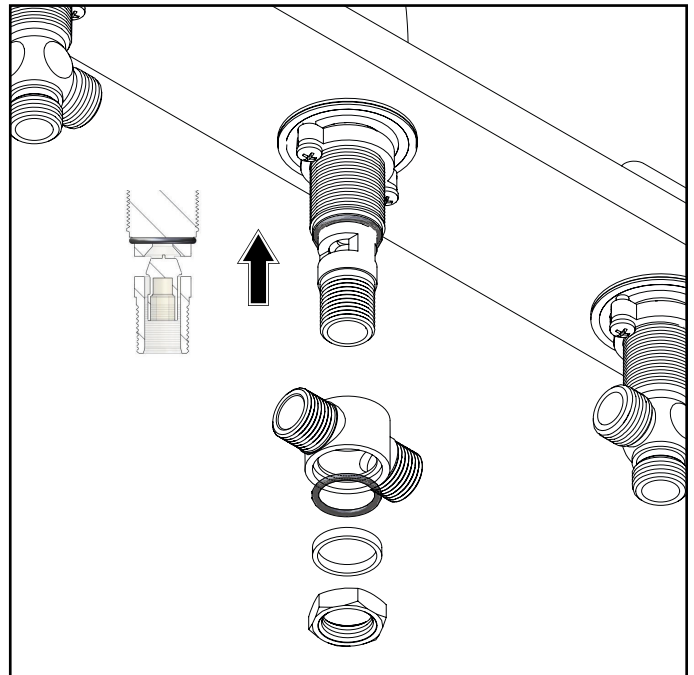

Place O-ring snug on diverter valve

INSTALLING THE TUB SPOUT

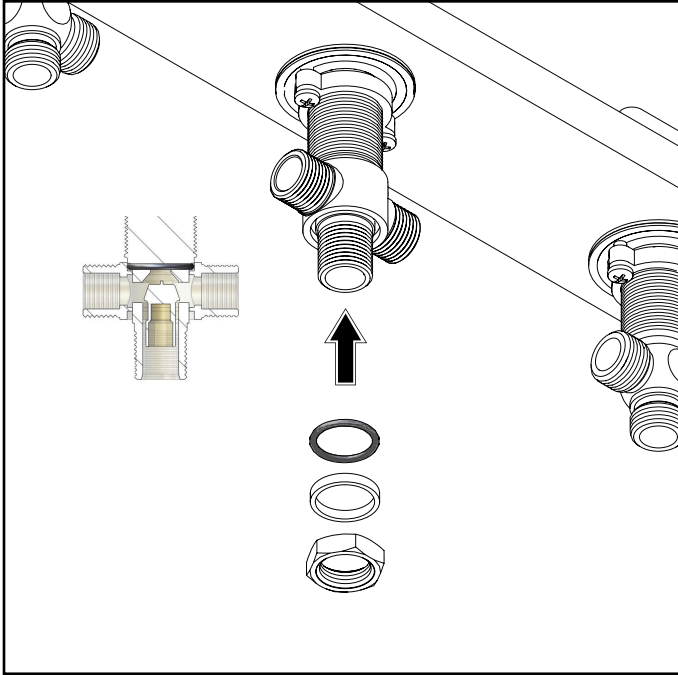

Place threaded brass connector onto O-ring. Ensure O-ring fits in brass connector groove.

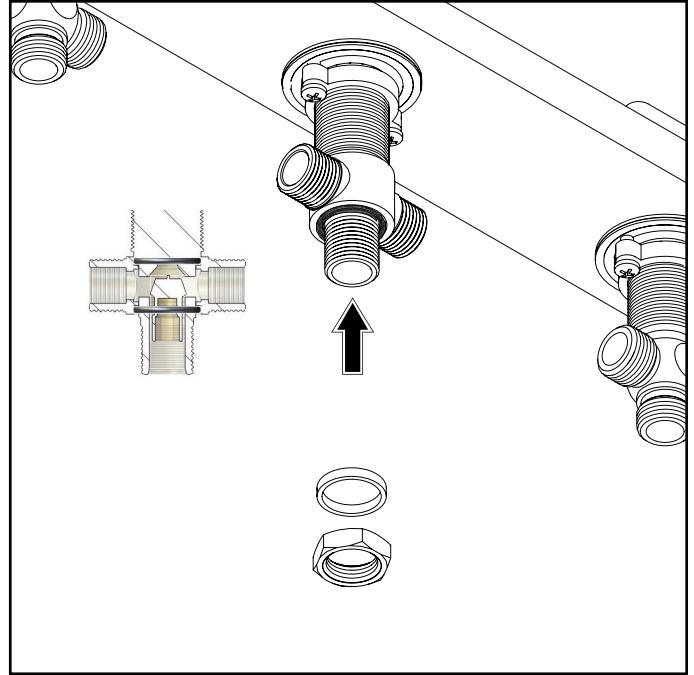

Place 2nd O-ring snug on brass connector groove

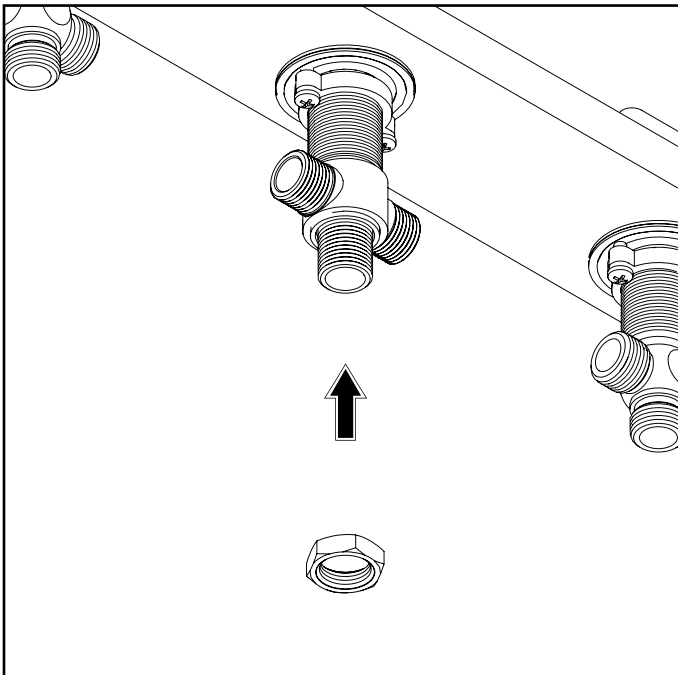

Place brass ring on top of 2nd O-ring from previous step

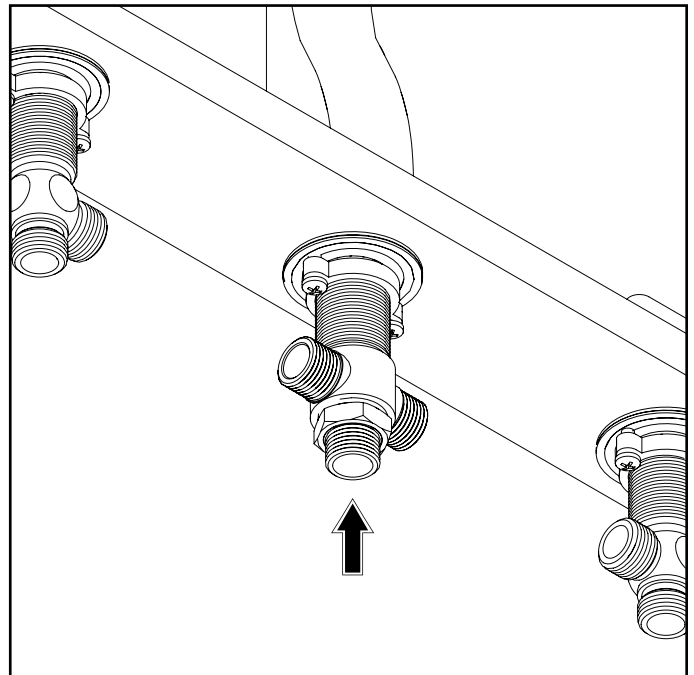

Insert hex nut over brass ring in previous step and tighten

INSTALLING THE HAND SHOWER

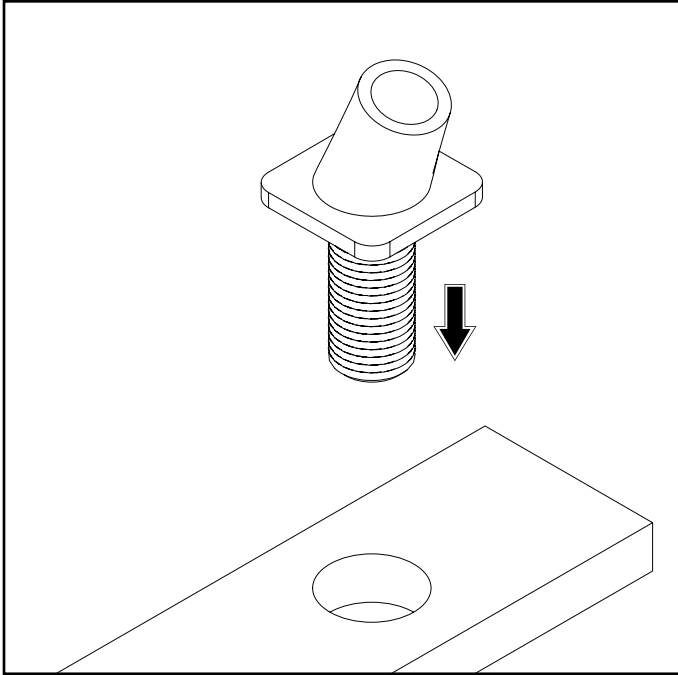

Drop hand shower deck holder into deck hole

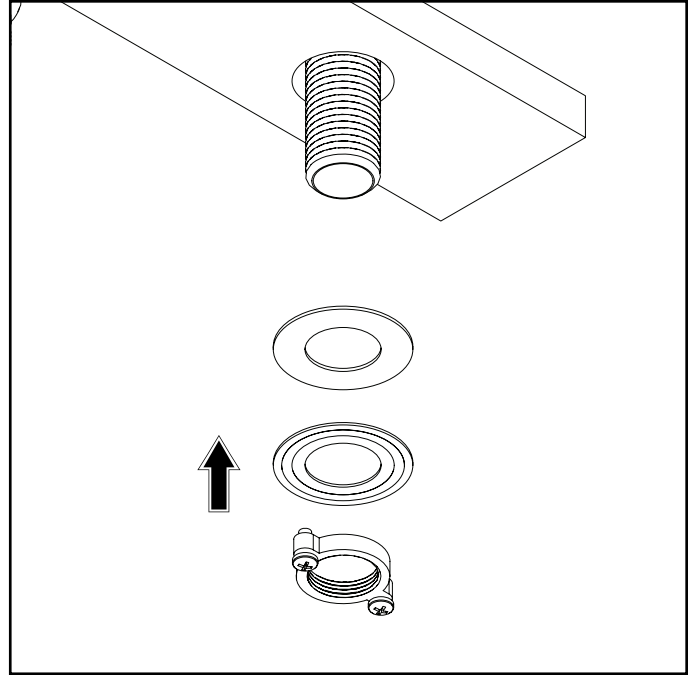

Insert & Tighten nut and washers from bottom of deck

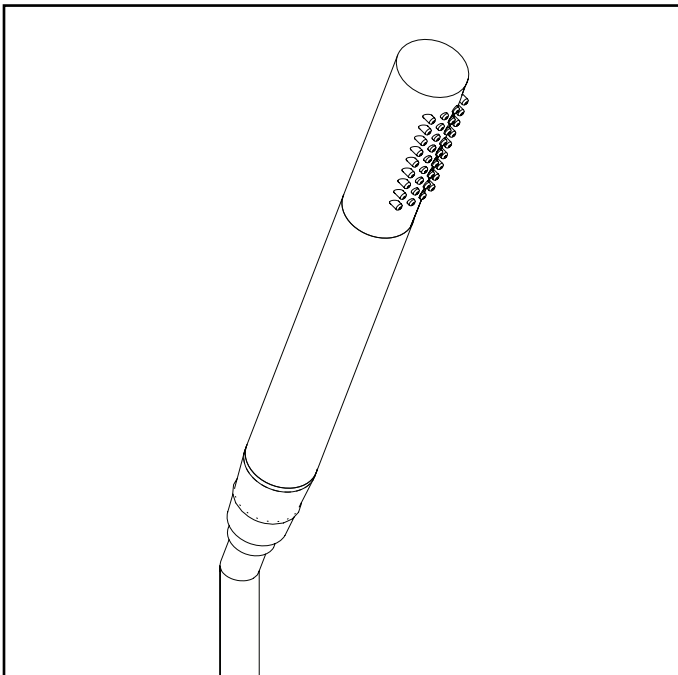

Attach hose to hand shower

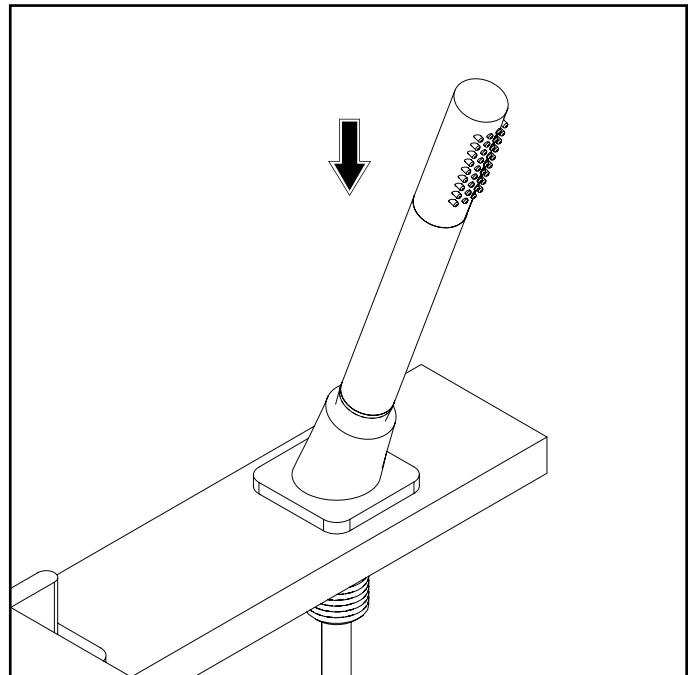

Drop hose down through deck hole

INSTALLING THE HOSES

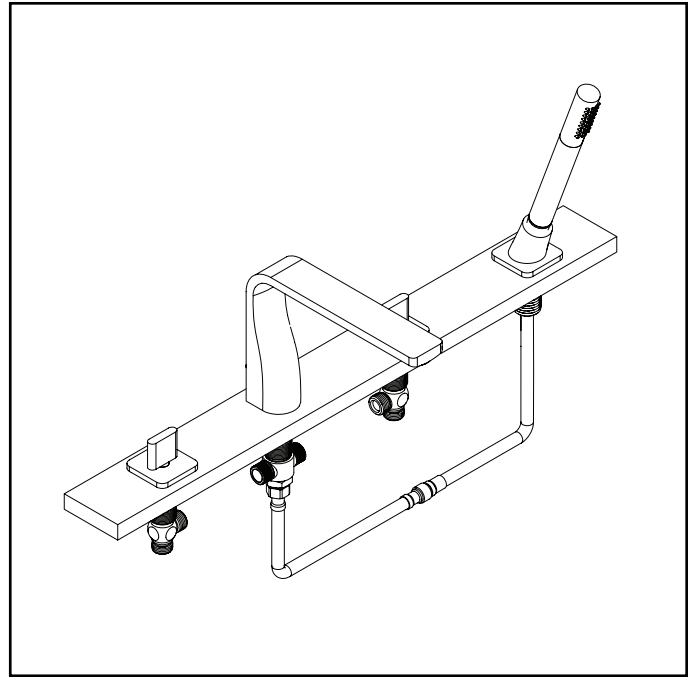
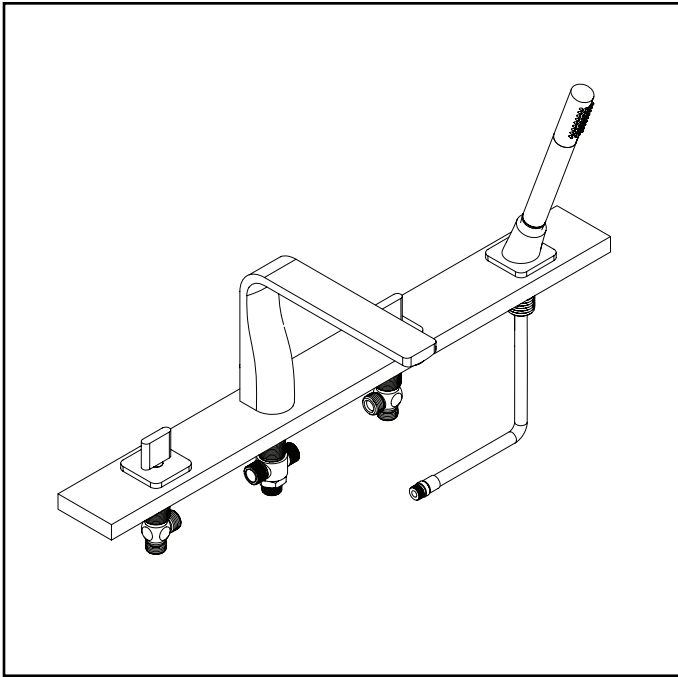

Connect 2nd piece of the hand shower hose

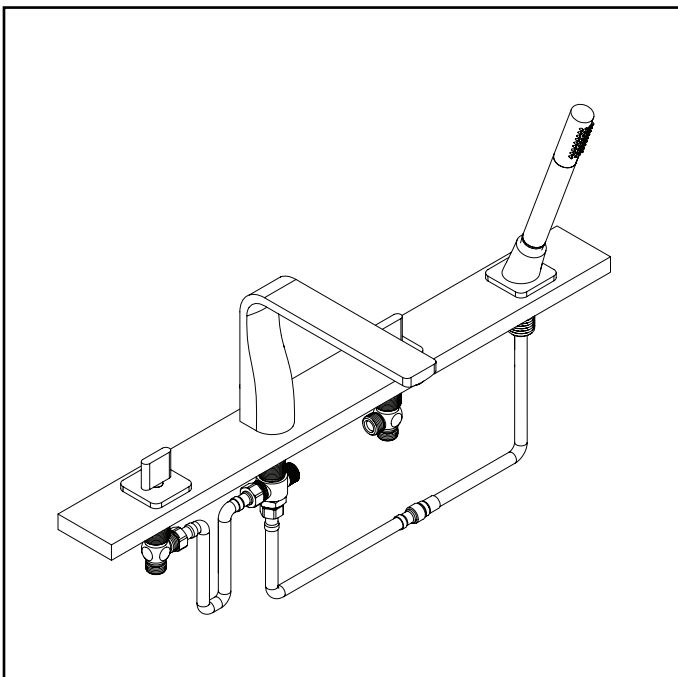

Connect Hot-side connection

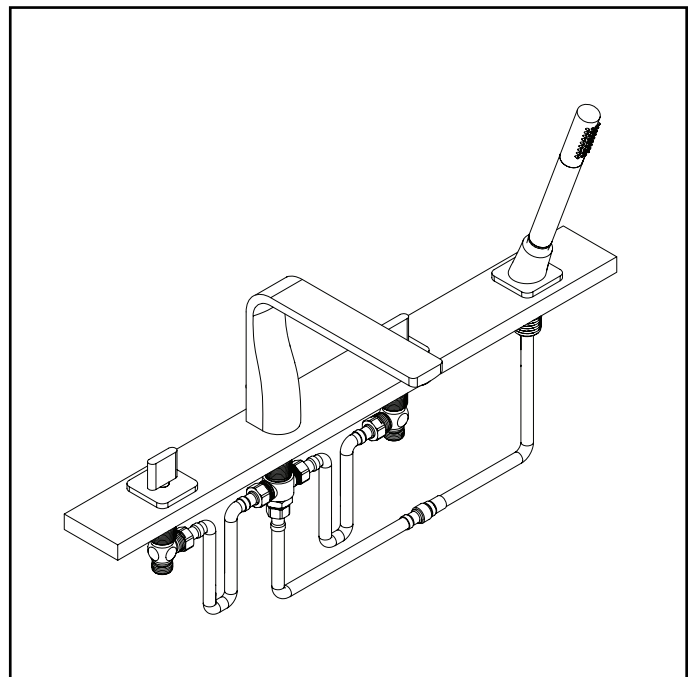

Connect Cold-side connection

TROUBLESHOOTING THE DIVERTER

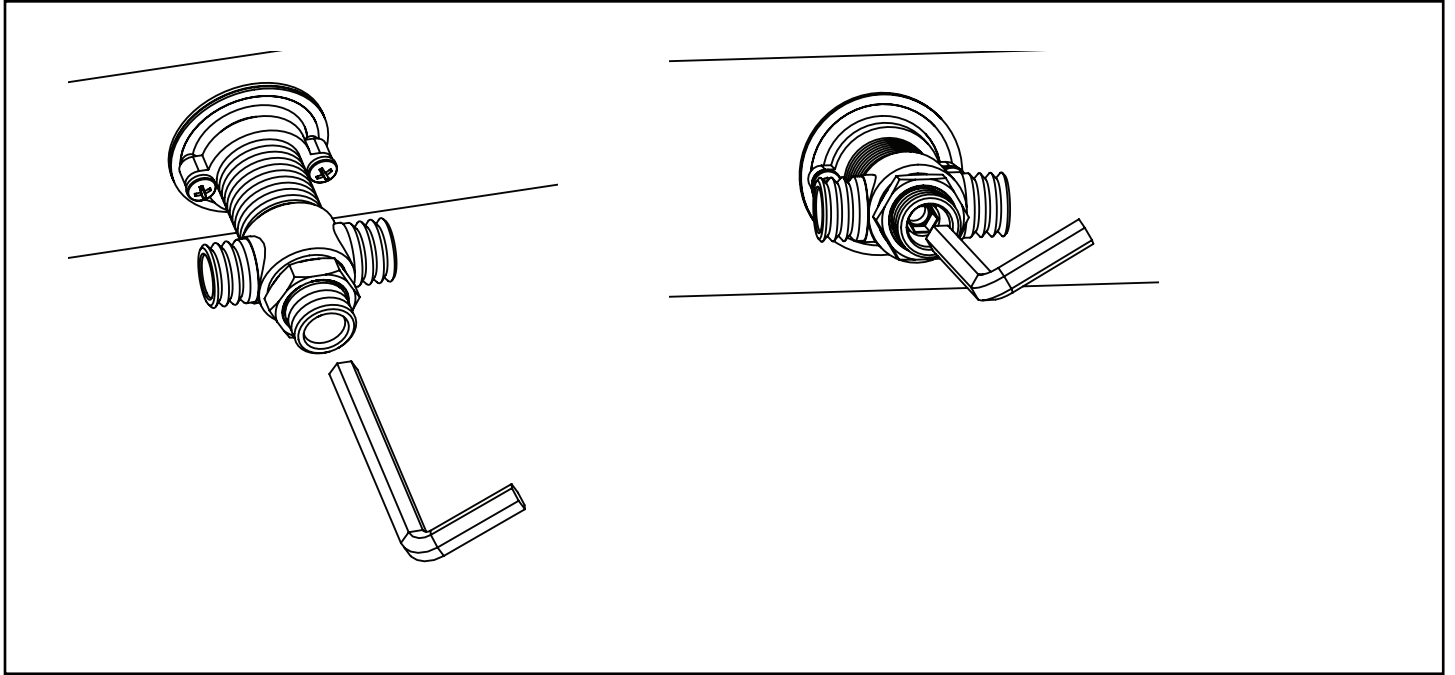

If diverter mechanism does not fully divert the water fully between the spout and the hand-shower, gently tighten the hex nut inside the hole at the bottom of the diverter outlet.